

● **ME-8108**

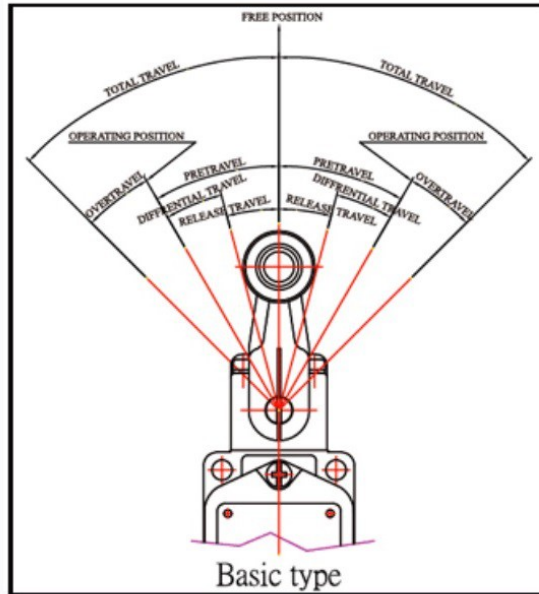
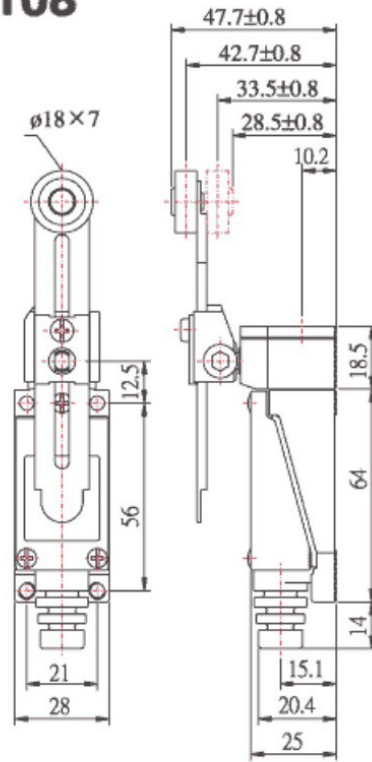

Characteristics:

OF: Operating Force Max	340g
RF: Release Force Min	21g
PT: Pretravel Max	20°
OT: Over Travel Min	75°
DT: Differential Travel Max	10°
TT: Total Travel Min	95°

Ratings:

5 A: 250V AC	(resistive)
0.4A: 115V DC	(resistive)

