

● **ME-8112**

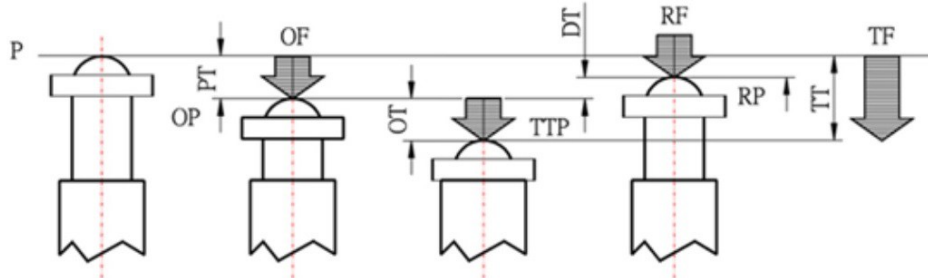
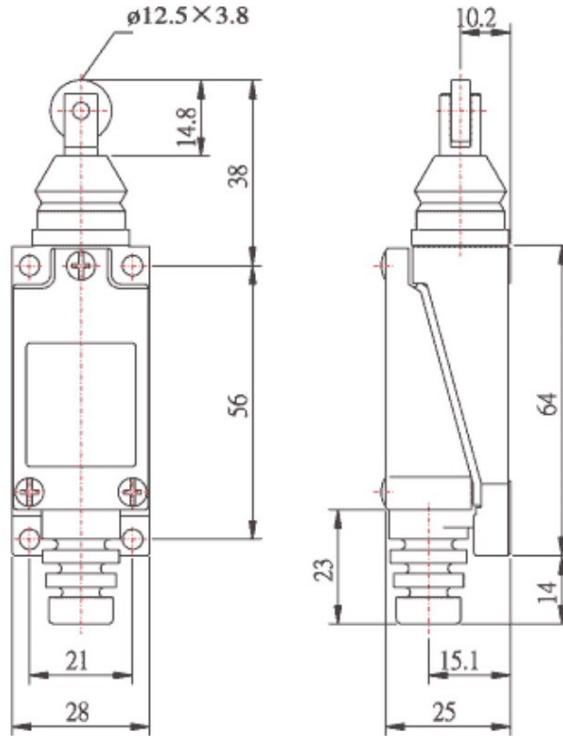

Characteristics:

OF: Operating Force Max	900g
RF: Release Force Min	150g
PT: Pretravel Max	1.5mm
OT: Over Travel Min	4.0mm
DT: Differential Travel Max	0.7mm
TT: Total Travel Min	5mm

Ratings:

5 A: 250V AC	(resistive)
0.4A: 115V DC	(resistive)

