

ME-9101

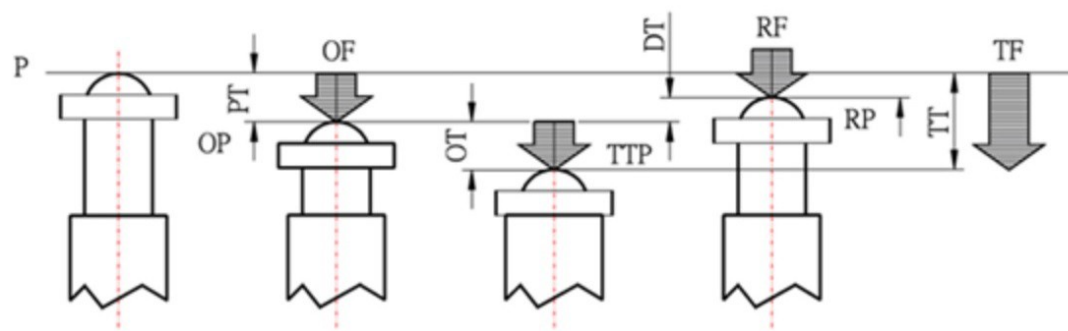
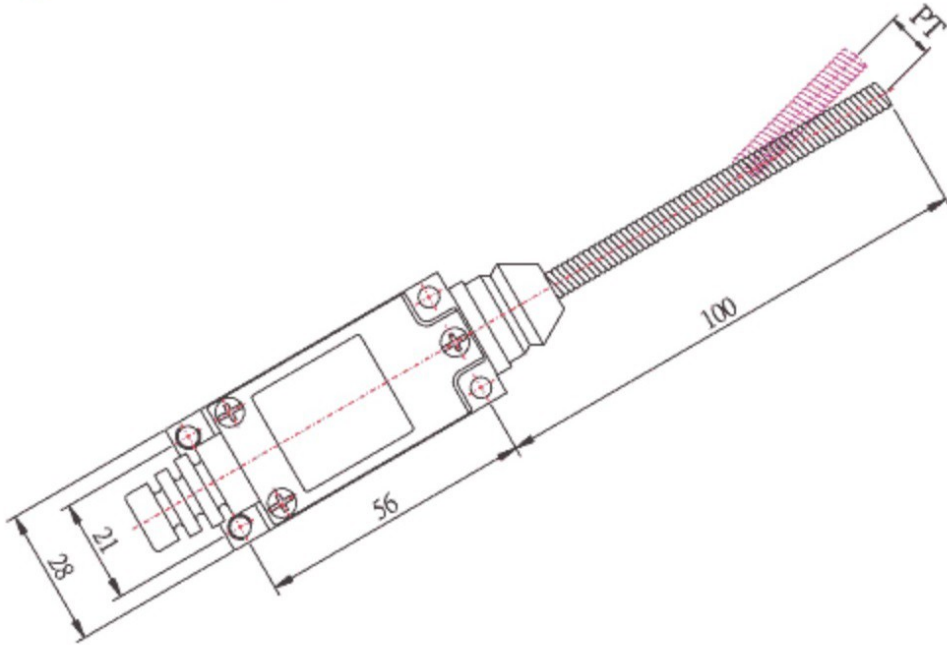

Characteristics:

OF: Operating Force Max	90g
RF: Release Force Min	-
PT: Pretravel Max	30mm
OT: Over Travel Min	20mm
DT: Differential Travel Max	-
TT: Total Travel Min	-

Ratings:

5 A: 250V AC	(resistive)
0.4A: 115V DC	(resistive)

