

MJ SERIES PRECISION OIL-TIGHT LIMIT SWITCHES

FEATURES

- Dustproof, oil tight, water-resistance
- IP67
- 10A 125 or 300 VAC
- -10°C to +80°C
- NO/NC contacts
- Wide choice of heads and actuators

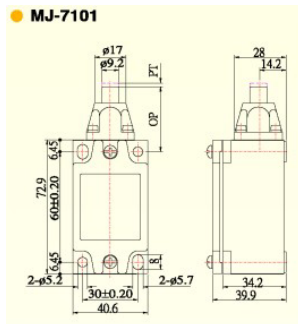

Item nr	Specification
MJ-7101	Metal limit switch, 2 screws, IP67
MJ-7101O	Metal limit switch, 3 screws, IP67

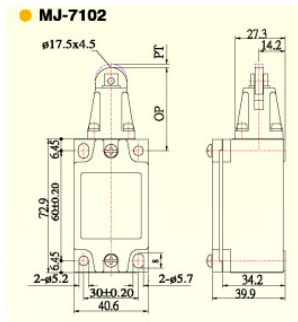

MJ-7102	Metal limit switch, 2 screws, IP67
MJ-7102O	Metal limit switch, 3 screws, IP67



MJ-7102R	Metal limit switch, 2 screws, IP67
MJ-7102RO	Metal limit switch, 3 screws, IP67

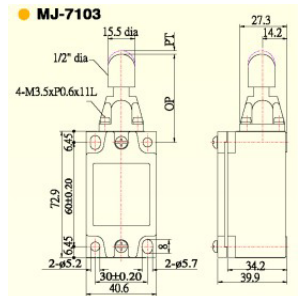

MJ-7103	Metal limit switch, 2 screws, IP67
MJ-7103O	Metal limit switch, 3 screws, IP67

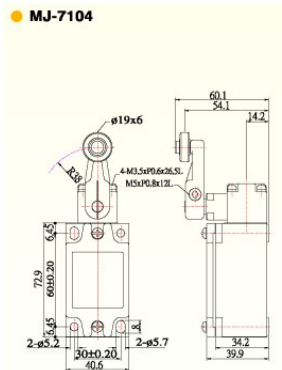

MJ-7104	Metal limit switch, 2 screws, IP67
MJ-7104O	Metal limit switch, 3 screws, IP67
MJ-7104-P	Metal limit switch, plastic roller, IP67
MJ-7104-26	Metal limit switch, 50 mm big rubber roller, IP67

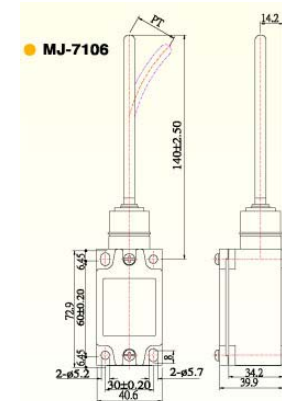

MJ-7106	Metal limit switch, 2 screws, IP67
MJ-7106O	Metal limit switch, 3 screws, IP67
MJ-7126	Metal limit switch, half spring with steel rod, IP67

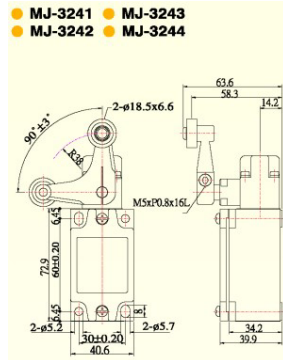

MJ-3241 Metal limit switch, 2 screws, IP67
MJ-3241O Metal limit switch, 3 screws, IP67
MJ-3241-M Metal limit switch, 2 screws, metal roller, IP67

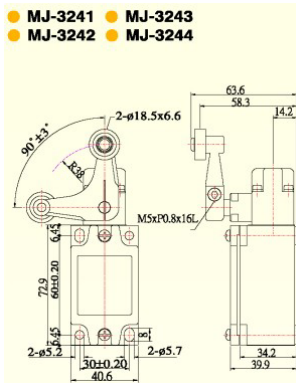

MJ-3242 Metal limit switch, 2 screws, IP67
MJ-3242-M Metal limit switch, 3 screws, metal roller, IP67

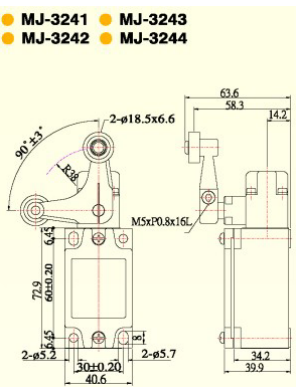

MJ-3243 Metal limit switch, 2 screws, IP67
MJ-3243-M Metal limit switch, 3 screws, metal roller, IP67

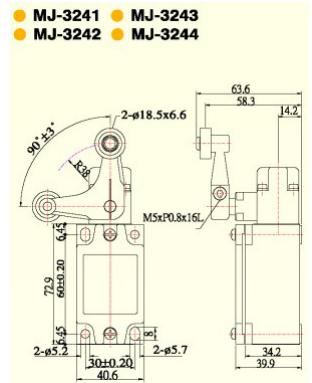

MJ-3244 Metal limit switch, 2 screws, IP67
MJ-3244-M Metal limit switch, 3 screws, metal roller, IP67

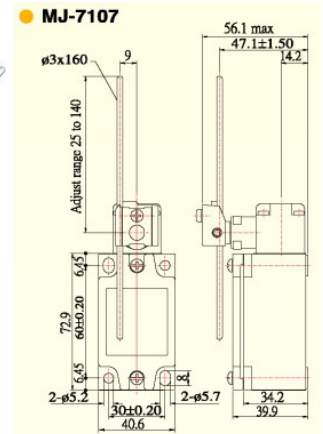

MJ-7107 Metal limit switch, 2 screws, IP67
MJ-7107O Metal limit switch, 3 screws, IP67
MJ-7107L Metal limit switch, 395mm long rod, IP67

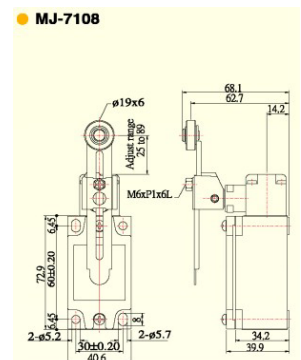

MJ-7108 Metal limit switch, 2 screws, IP67
MJ-7108O Metal limit switch, 3 screws, IP67
MJ-7108-P Metal limit switch, plastic roller, IP67
MJ-7108-26 Metal limit switch, 50 mm big rubber roller

● **MJ-7204**

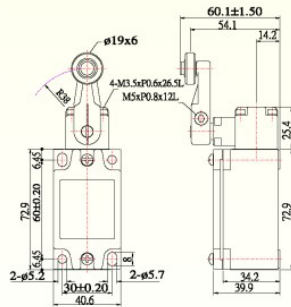

- MJ-7204 Metal limit switch, 2 screws, IP67
- MJ-7204O Metal limit switch, 3 screws, IP67
- MJ-7204-P Metal limit switch, plastic roller, IP67
- MJ-7204-26 Metal limit switch, 50 mm big rubber roller, IP67



MJ-7000 Switch block

● **MJ-7207**

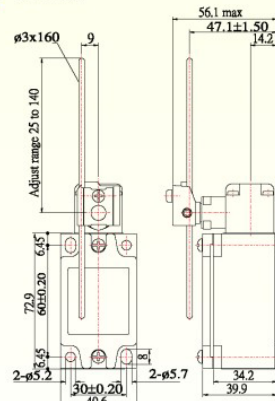

- MJ-7207 Metal limit switch, 2 screws, IP67
- MJ-7207O Metal limit switch, 3 screws, IP67
- MJ-7207L Metal limit switch, 2 screws, 395 mm long rod, IP67

● **MJ-7208**

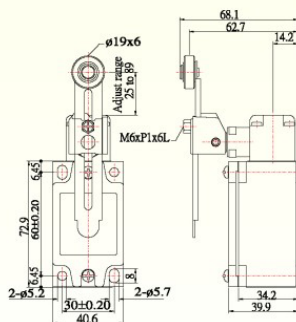

- MJ-7208 Metal limit switch, 2 screws, IP67
- MJ-7208O Metal limit switch, 3 screws, IP67
- MJ-7208-P Metal limit switch, plastic roller, IP67
- MJ-7208-26 Metal limit switch, 50 mm big rubber roller, IP67